

### GENERAL

ISV-E 493 monophase outdoor switch disconnecter, is designed to be employed in rural or suburban districts distribution networks up to 52 kV and they are used for disconnection of lines or transformation spots on outdoor pole. It is hinge disconnection with central insulating rod.

ISV-E 493 can be equipped with lower earthing blades mechanically interlocked with the line blades and integrate itself with a fuse holder suitable for IEC 282-1/DIN 43625 fuses. The fuse intervention cause the opening of the ISV-E switch disconnecter automatically.

### MOUNTING

ISV-E outdoor switch disconnecter can be **mounted** on pole in vertical (or horizontal) position.

It is suitable for metal, concrete or timber poles, through standard fixing devices or special on request.

### CURRENT CARRYING SET

**Moving contact** consists in two blades mounted in parallel.

**Fixed contact** is made of bent sheet having a feature, which ensure an optimal working.

For both, material is copper Cu-ETP 99,90 tin-coated. Contacts pressure is controlled by stainless steel springs during normal conditions and by the

self-tightening action when high current flow through them in particular conditions.

Stainless steel bolts or brass clamps on request, carry out connecting of copper or aluminium alloy cables from 4.5-to14 mm of diameter.

All small components like bolts, pins of the current carrying set, are made of stainless steel

### BREAKING DEVICE

ISV-E 493 outdoor switch disconnecter is equipped with a device that allows a load **breaking capacity**. It consists of a housing containing moving and fixed arc contact.

They are driven by the main contact during the opening and closing operations, this allows arc extinguishing without any flash-over.

### INSULATORS

**Insulating components** used are:

- **Composite in fibre glass and silicone rubber**

They are in according to IEC 61952 standards.

Insulators have hot dip galvanized cast iron fittings.

Different leakage distance can be chosen according to the environment pollution level.

### OPERATING MECHANISM AND OPERATING DEVICES

**Operating mechanism** allows fast closing and opening operations obtained by means of a spring. The opening/closing speed is independent of the operator. The fuse intervention cause the opening of the switch disconnecter

**Operating devices** used are the following:

- **Manual bottom transmission device** consists on an handle control manoeuvrable directly.

- **Motorized command device**

It allows to control the isolator from remote. The manual or motorized local manoeuvre remains however possible. Several supply voltages are possible to agree with the customer.

All the types of commands are connected to the isolator with rod and combined levers.

The devices are realized with structural steel and welded steel sheet, protect with treatment of hot-galvanizing.

Transmitted devices are braced to the operating mechanism by means of one or more pipe transmission rods and transmitting rod joint. Optional padlock can be fitted.

All operating devices are made of welded structural and bent metal sheets, protected against corrosion by hot-dip galvanization treatment.

Different operating devices are available on request.

### MANUFACTURING, STANDARDS, QUALITY ASSURANCE

ISV-E is an outdoor switch disconnecter product of Eleron experience.

The Eleron **manufactures** directly main parts of disconnecter as contacts, frame, operating mechanism and devices. Remaining parts come from chosen suppliers, finally Eleron carry out to assembling and test the product.

An internal standard **Quality Assurance** in compliance with governs all manufacturing process UNI EN ISO 9001 standard

Before shipment, all ISV-E 519 outdoor switch disconnecters are subject to the following **routine tests**:

- Dielectric test
- Measurement of the resistance of the main circuit
- Mechanical operating test

ISV-E outdoor switch disconnecter comply with the following **standards**:

- International IEC 62271-102 , IEC 60265, EN 50152-2
- National CEI EN 62271-102, CEI EN 60265

### TECHNICAL CHARACTERISTICS

Ambient temperature	[°C]	-25÷40
Nr. of mechanical manoeuvre	Classe MO	2000
Ice making capacity	[mm]	10
<b>Isolator's electrical characteristics</b>		
Rated normal voltage 'Ur'	[kV]	27,5-36
Rated withstand voltage toward earth and between phases (50-60 Hz/1 min.)	[kV]	95
Rated withstand voltage between open contacts (50-60 Hz/1 min)	[kV]	110
Impulse withstands voltage toward earth and between phases 'Up'	[kV]	250
Impulse withstands voltage between open contacts	[kV]	290
Rated normal frequency	[Hz]	50
Rated normal thermal current 'Ir'	[A]	Up to 2000
Rated breaking current 'I1'	[A]	Up to 2000
Rated admissible short-time current (1 sec./3 sec.) 'Ik'	[kA]	25
Max permanent tension (between fase and earth) $U_{max1}$	[kV]	27,5
Max non-permanent tension (5 min. between fase and earth) $U_{max2}$	[kV]	29
<b>Auxiliary contact (optional)</b>		
Nominal current 'Ith'	[A]	10
Nominal tension of isolation 'Ui'	[V]	500Vac / 600Vdc
<b>Earthing switch's electrical characteristics (optional)</b>		
Rated normal voltage	[kV]	27,5
Rated withstand voltage toward earth and between phases (50-60 Hz/1 min.)	[kV]	95
Impulse withstands voltage toward earth and between phases	[kV]	250
Rated admissible short-time current (3 sec.)	[kA]	12,5 / 16 / 25 / 40

**OVERALL DIMENSIONS**

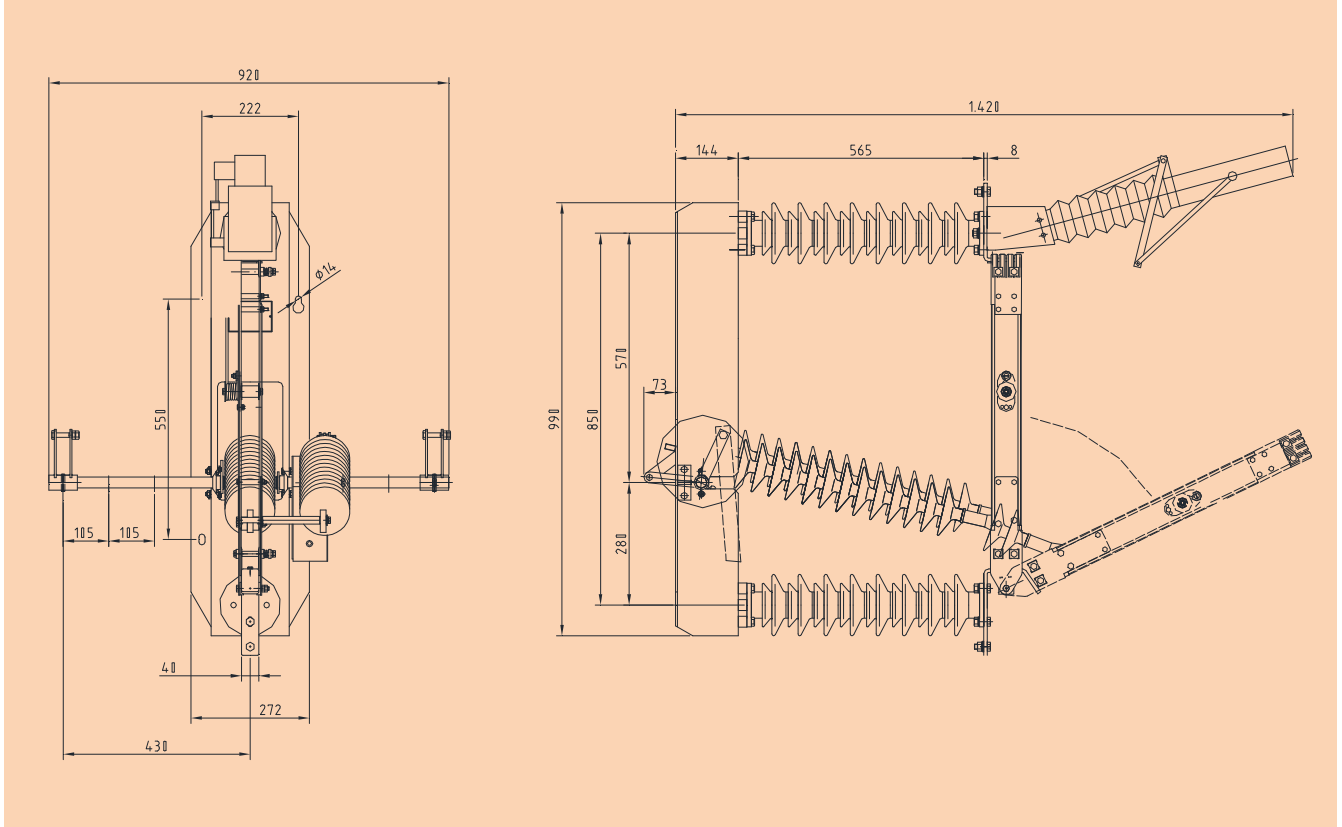
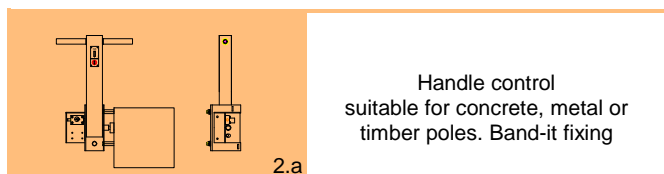
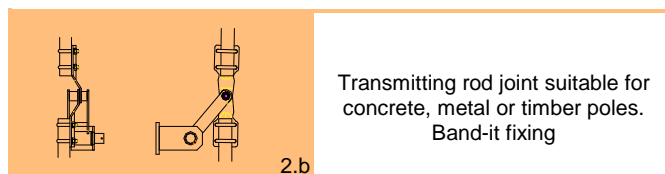

Fig.1

**OPERATING DEVICES AND ACCESSORIES**



Handle control suitable for concrete, metal or timber poles. Band-it fixing



Transmitting rod joint suitable for concrete, metal or timber poles. Band-it fixing

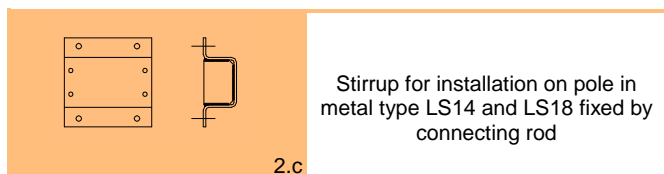

Stirrup for installation on pole in metal type LS14 and LS18 fixed by connecting rod

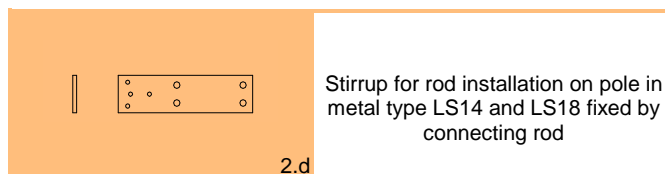

Stirrup for rod installation on pole in metal type LS14 and LS18 fixed by connecting rod

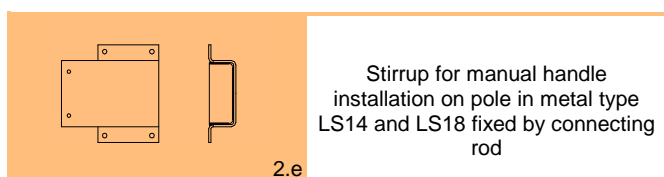

Stirrup for manual handle installation on pole in metal type LS14 and LS18 fixed by connecting rod

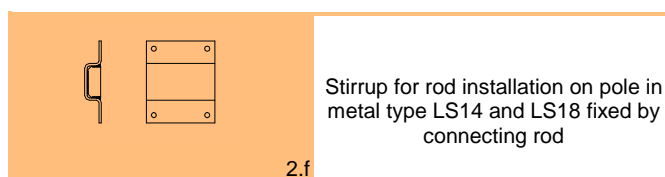

Stirrup for rod installation on pole in metal type LS14 and LS18 fixed by connecting rod

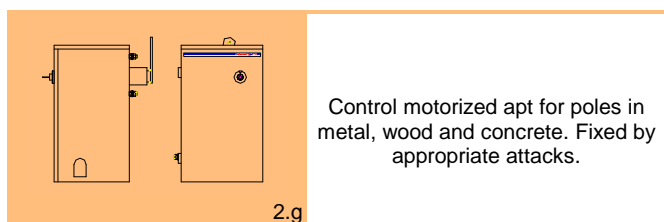

Control motorized apt for poles in metal, wood and concrete. Fixed by appropriate attacks.

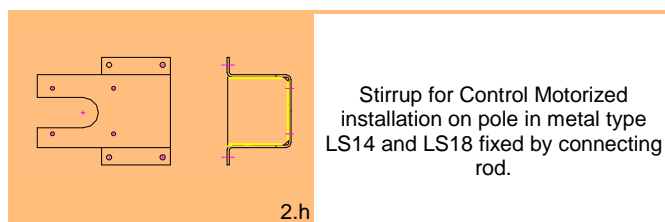

Stirrup for Control Motorized installation on pole in metal type LS14 and LS18 fixed by connecting rod.



Rod for fixed device for poles type LS14

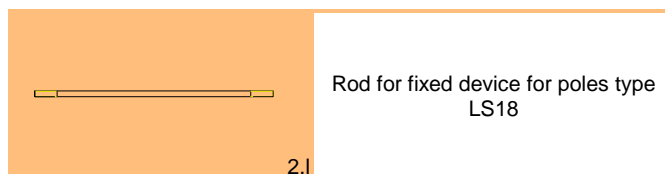

Rod for fixed device for poles type LS18

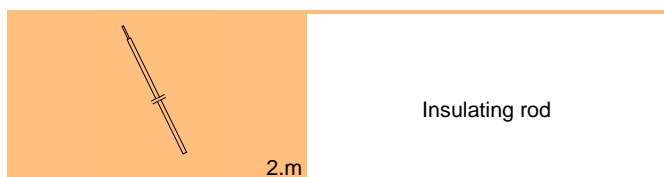

Insulating rod

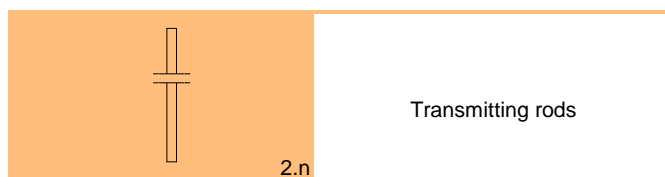

Transmitting rods

**TYPICAL INSTALLATION ON POLE**

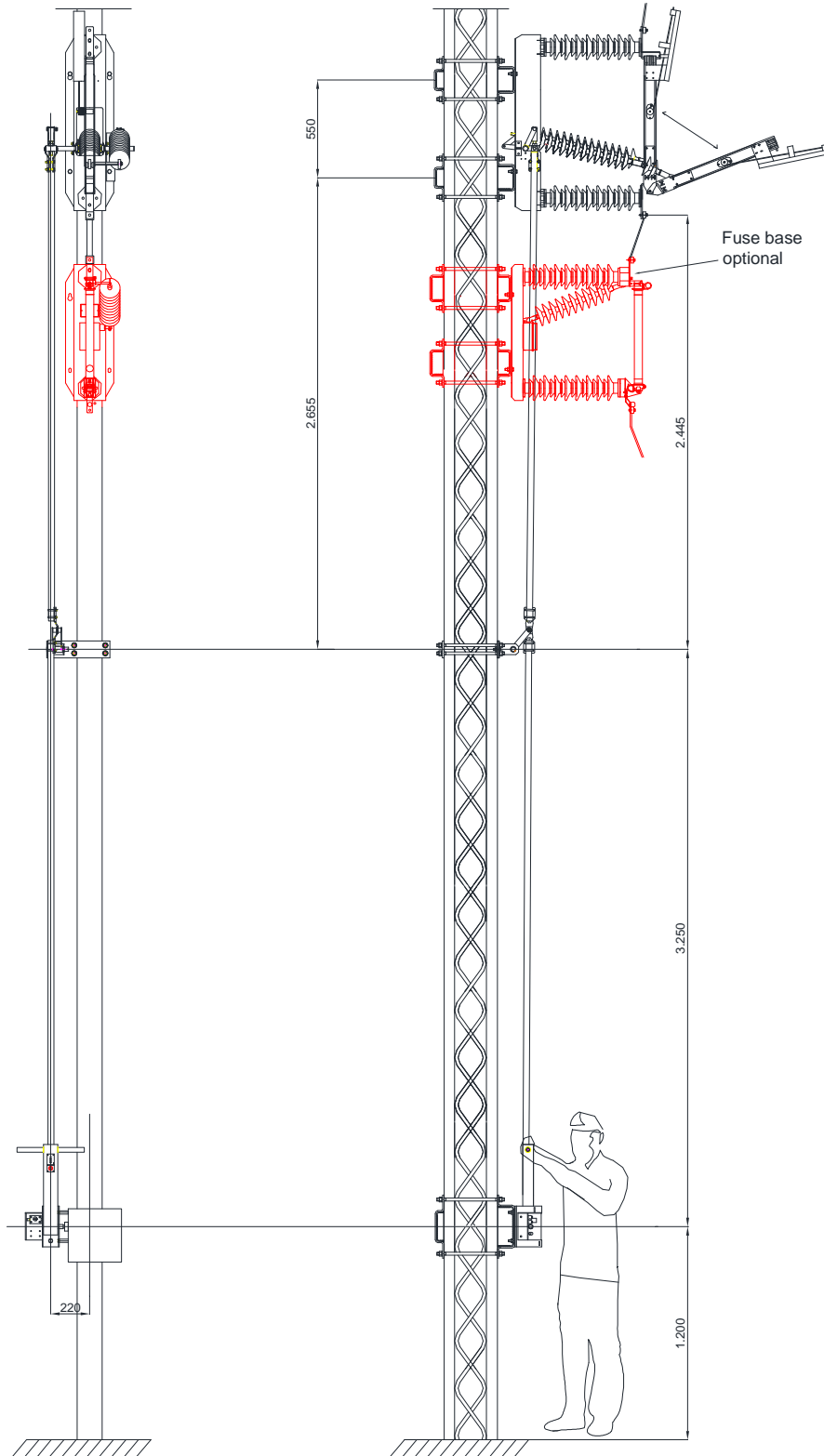

Fig.3.a

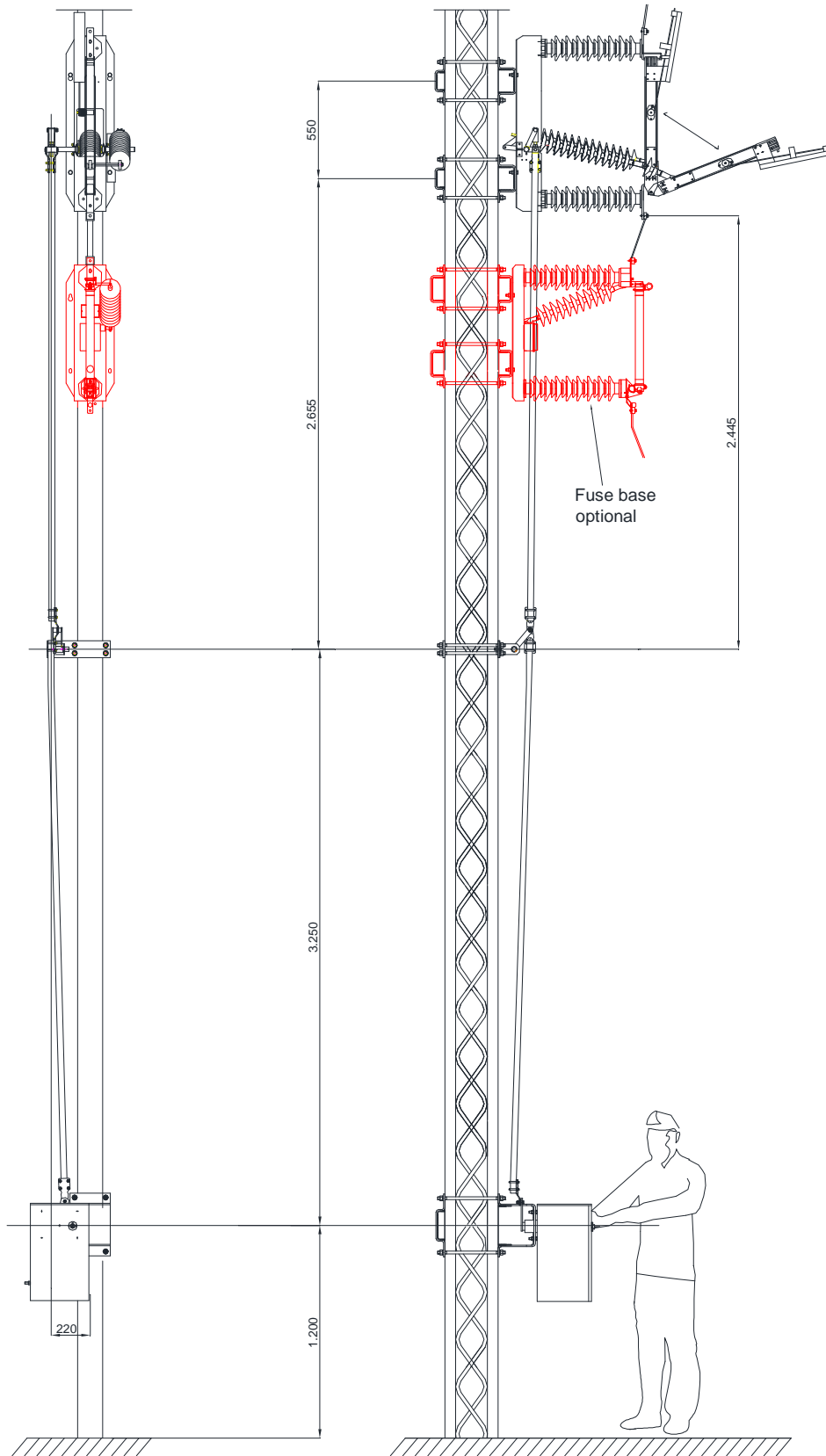

Fig.3.b

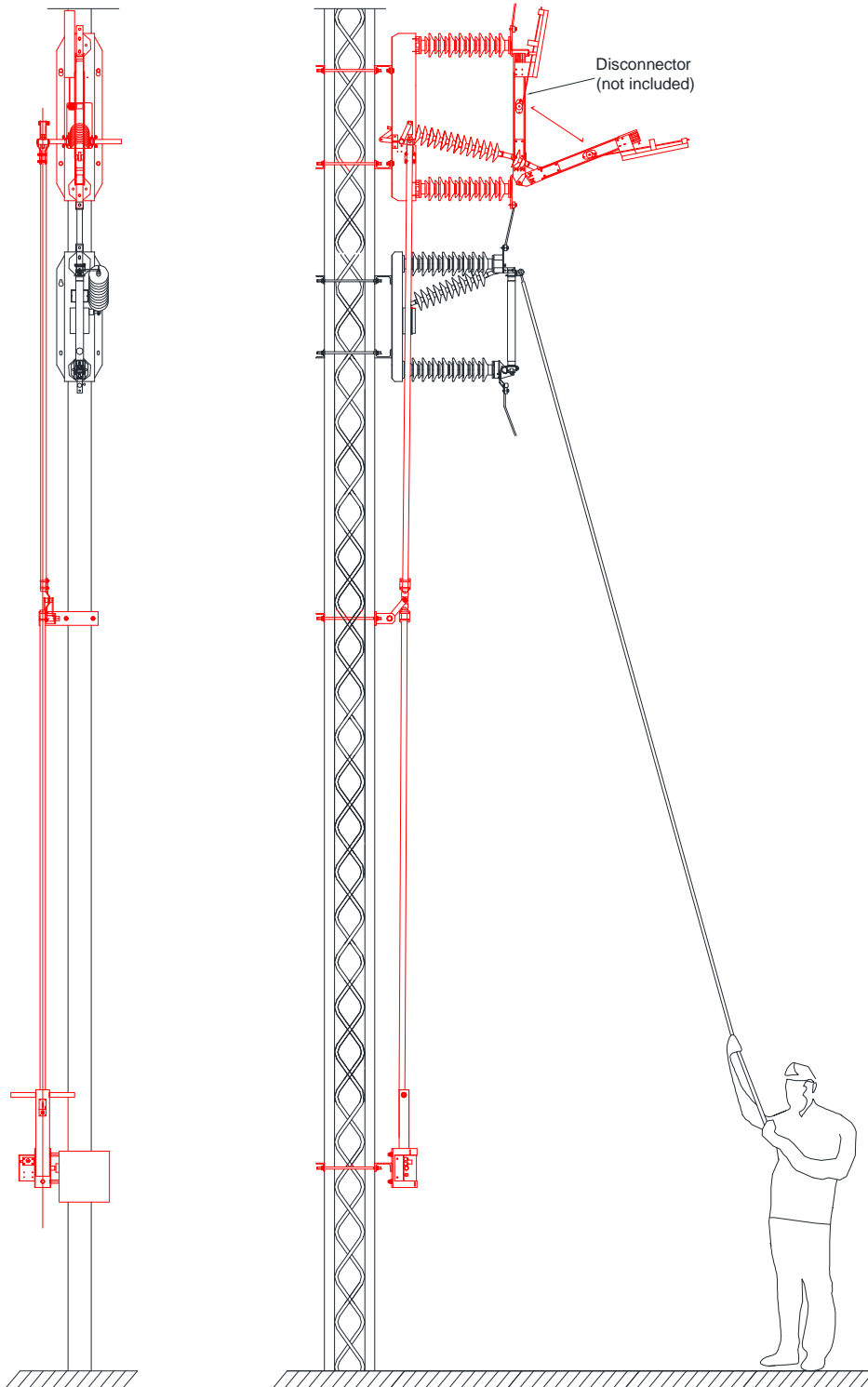

Fig.3.c





